

OUTDOOR LIGHTING FOR PROFESSIONALS

# THE BOOK

O F I N - L I T E

in-lite

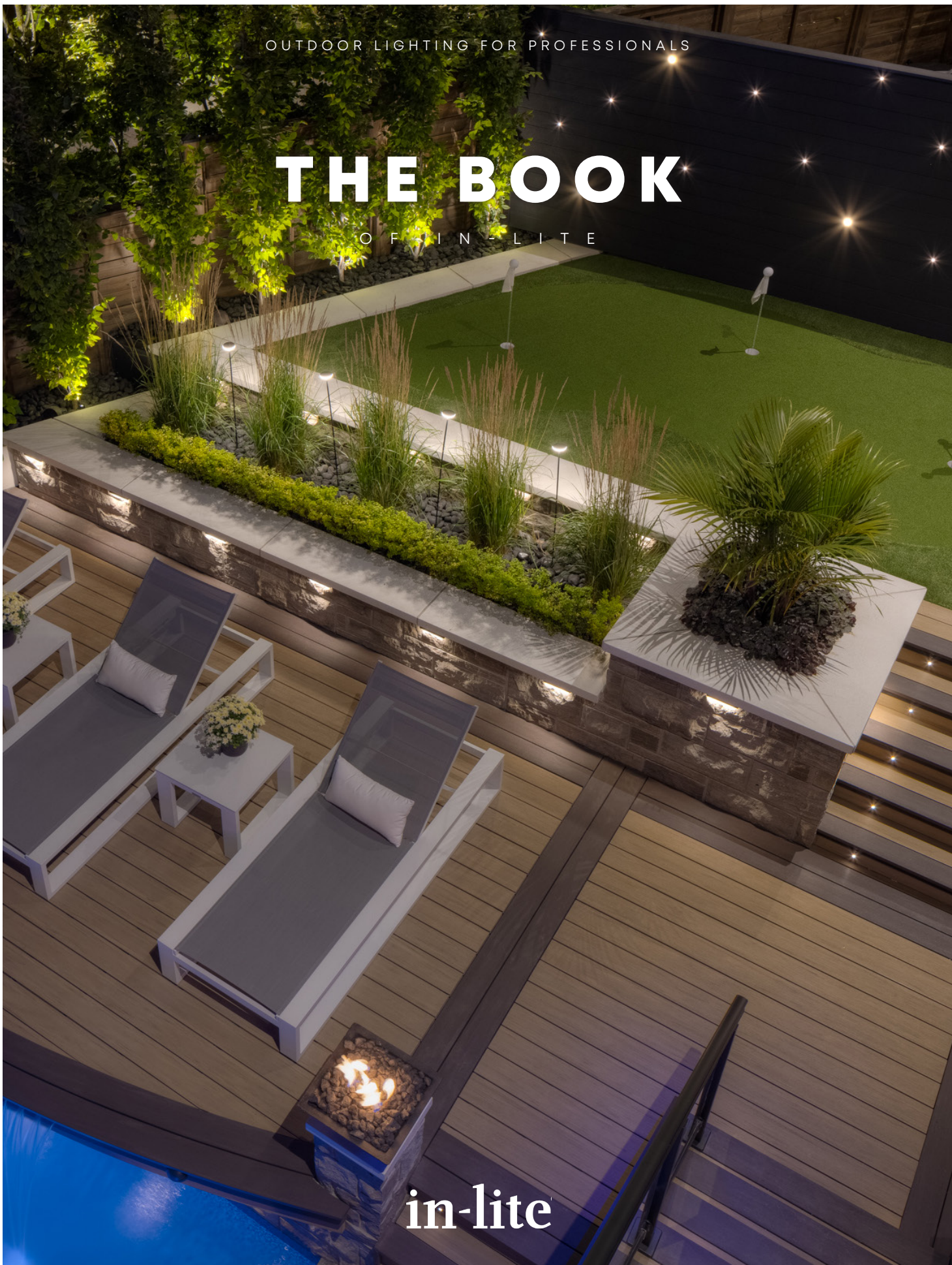





## WHY IN-LITE?

in-lite is the fastest growing outdoor lighting manufacturer in the industry for a reason. Our high-quality products, patented connection system, and innovative technology, are built with the professional in mind. We are committed to helping professionals grow their business through lighting and beyond by providing unbeatable customer service, extensive training and education, and the best products on the market.

## EASY-LOCK CONNECTOR

The EASY-LOCK Connector is in-lite's patented connection system. The connector pierces the jacket of the low-voltage cable and releases a proprietary gel to create an air-tight seal by simply twisting the cap onto the body of the connector. The EASY-LOCK is made of high quality materials and makes the in-lite system easy to install by removing the need for wire splicing.

*"[The] EASY-LOCK has solved the most common problem in the lighting profession - call-backs! We have seen our lighting installation call backs drop from a rate of 30% to almost nothing."* - **MATT BELL, IN-SIDER**



LEARN MORE ABOUT THE EASY-LOCK

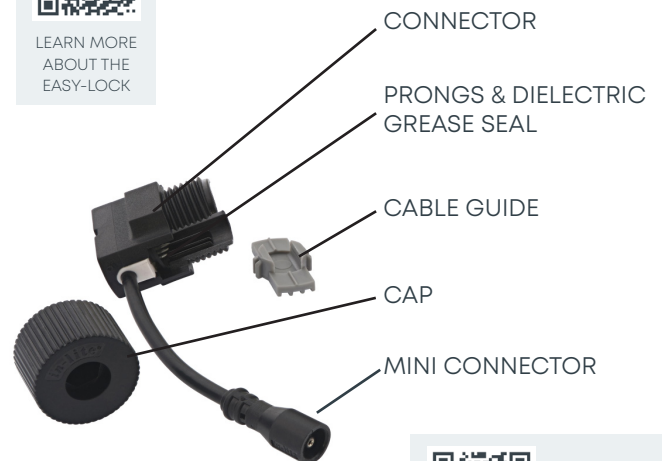

LEARN MORE ABOUT CRI

## CRI (COLOR RENDERING INDEX)

So, what is CRI? CRI evaluates the color rendition and accuracy of objects under manufactured light compared to how those objects would look under natural light (100 CRI). The higher the numerical value of CRI, the better the light will reproduce those vibrant, beautiful colors. The quality of in-lite products is unmatched. We use only the highest quality LED chips in our fixtures to ensure the best quality light possible. With light output as high as CRI 98, we promise our lights will make your projects stand out and highlight key elements in the way they deserve.



CRI 60-70



CRI 70-80



CRI 80-90



CRI 90-100





# CUSTOMER SERVICE EXCELLENCE

**OUR CUSTOMER EXPERIENCE TEAM IS ALWAYS READY TO  
HELP GUIDE YOU TO BE THE MOST SUCCESSFUL YOU CAN BE.**

+1-833-472-9960 | [info@in-lite.com](mailto:info@in-lite.com) | [www.in-lite.com](http://www.in-lite.com)

*“The support and service I get from the company is unbeatable. When I have a question, it is answered quickly and timely and I have quite frankly never had a problem.” - BRANDON DUECK, IN-SIDER*

## THE BEST CUSTOMER SERVICE IN THE INDUSTRY

The in-lite team is dedicated to providing you with the support you need every step of the way. Whether you need help with installation, product selection, troubleshooting, installation design, or any other resources we provide - we're happy to help!

Our team is educated, experienced, and ready to answer any questions you may have.



CONTACT  
US





# CHANGE THE WAY YOU SEE COLOR

We have always believed in creating products with the highest quality light output on the market and the concept for our color changing lights was no exception. Unlike other RGB lights in the outdoor living industry, we wanted to truly reimagine the way you see color. By building lights that not only produce extraordinary light quality but also feature innovative technology and control, we continue to push the limit of outdoor lighting.

Unleash your creativity with our TONE products and SMART technology.







### SMART SCOPE TONE

SKU: 10401050

Output: 6.0 W

Installation value: 9.5 VA

Color temperature: 3100 K

CRI: RGBW

\*Can now emit both the familiar in-lite warm white and RGB light



### SMART EVO FLEX TONE

SKU: 10250400

Output: 2.5 W

Installation value: 4.5 VA

Color temperature: 3100 K

CRI: RGB

\*Can now emit both the familiar in-lite warm white and RGB light

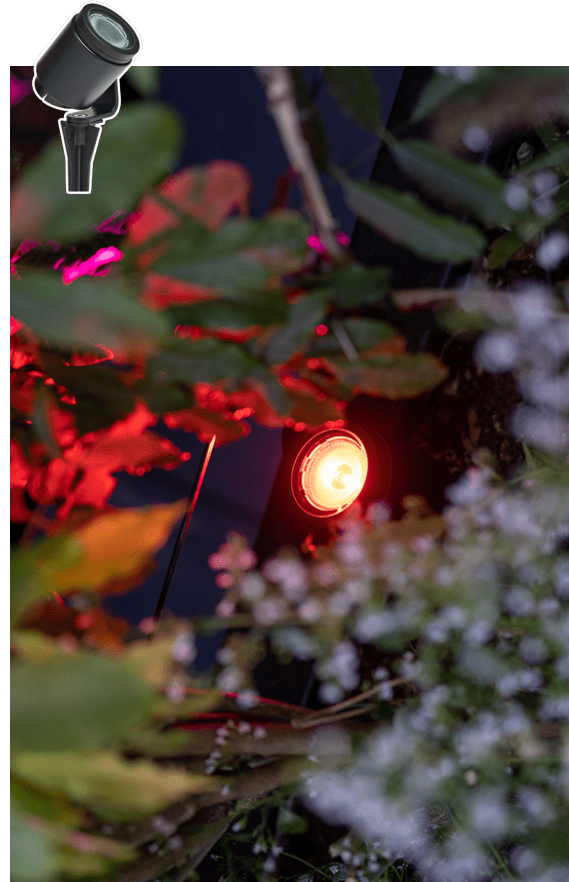

# IN-LITE SMART TONE



LEARN MORE ABOUT  
SMART TONE

## THE CORE OF OUR RGB VISION

We believe that color lighting should be used as an extra layer of lighting in an outdoor space. Adding pops of color around seating areas, patios, outdoor kitchens, and bars, creates a unique vibe that sets the tone for the night ahead. Celebrate holidays, support your favorite sports team, or even set the mood for date night. Combined with our beautiful CRI 90+ white lights on softscapes (trees and plants), creating the perfect atmosphere has never been easier.





# IN-LITE JUST GOT SMARTER

Our team is dedicated to providing you with the best products on the market to take your projects to the next level. We are constantly developing and designing our system to be adaptable, high quality, and user-friendly.



## IN- NOVATION



With the use of a SMART BRIDGE and SMART HUB, your in-lite system is now able to operate from anywhere in the world with the click of a button, or the sound of your voice.



### SMART BRIDGE

The SMART BRIDGE is an in-lite smart system accessory that creates a bridge to the internet in order to operate and adjust outdoor lighting from anywhere in the world. Integrate the in-lite smart system with 'smart home' systems like Google Home, Apple Homekit and Amazon Alexa.



LEARN MORE ABOUT  
SMART PRODUCTS



### SMART MOVE

With the wireless motion detector SMART MOVE, your outdoor lighting switches on automatically when you walk or drive past it. This gives you enough light to find your way, so you'll never have to fumble in the dark again!



### SMART EXTENDER

The SMART EXTENDER was developed to strengthen the Bluetooth connection to the SMART-HUB 150 and in-lite app indoors due to external factors.

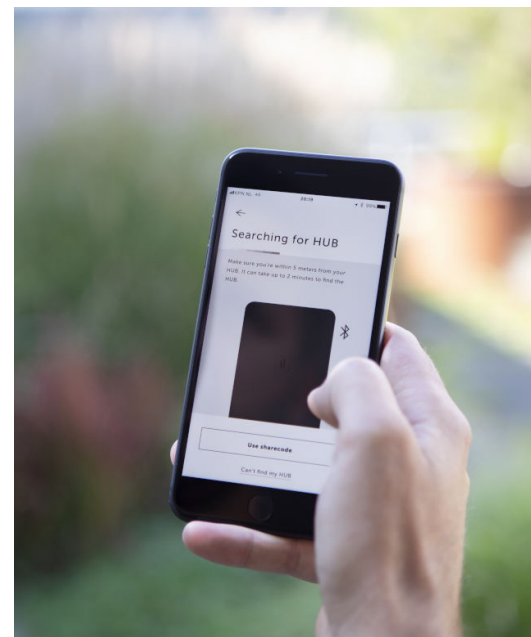





# SMART TRANSFORMER

## SMART HUB-150 ★ MUST-HAVE

The SMART HUB-150 transformer is high-quality, modern, and innovative. It is controlled exclusively by the in-lite smartphone app for iOS and Android. All smart products can easily be used in combination with a SMART HUB.



LEARN MORE ABOUT THE SMART HUB-150

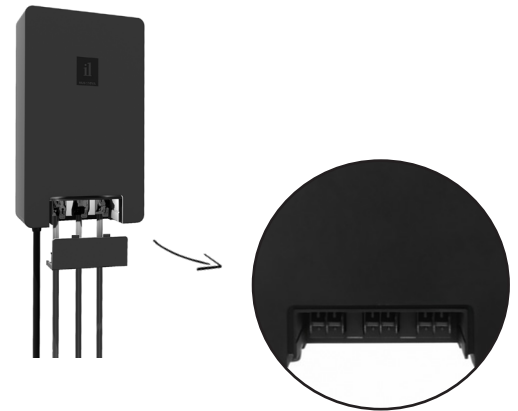

## SMART EVO FLEX



## SMART SCOPE TONE



# SMART DIMMING



## IN-LITE MOTION

in-lite Motion makes it possible to easily tilt the light source in the BIG NERO and BIG NERO NARROW fixtures without having to disassemble anything. A magnet on the in-lite logo on the fixture is used to adjust the light source to the fixture to the desired position and easily create the perfect lighting effect.



# SPOT LIGHTS



## NERO

SKU: 10103401  
Output: 3.0 W  
Installation value: 4.7 VA  
Color temperature: 3100 K  
CRI: 91



## BIG NERO

SKU: 10103451  
Output: 7.5 W  
Installation value: 11.9 VA  
Color temperature: 3100 K  
CRI: 91



## MINI SCOPE ★ MUST-HAVE

SKU: 10400601  
Output: 1.0 W  
Installation value: 2.0 VA  
Color temperature: 2900 K  
CRI: 93



## BIG NERO NARROW

SKU: 10103460  
Output: 7.5 W  
Installation value: 11.9 VA  
Color temperature: 3100 K  
CRI: 91



## MINI SCOPE DUO

SKU: 10400606  
Output: 2x 1.0 W  
Installation value: 2x 2.0 VA  
Color temperature: 2900 K  
CRI: 93

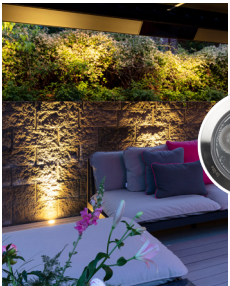

## FLUX

SKU: 10103201  
Output: 1.5 W  
Installation value: 2.5 VA  
Color temperature: 3000 K  
CRI: 92



## SCOPE ★ MUST-HAVE

SKU: 10400503  
Output: 3.0 W  
Installation value: 5.2 VA  
Color temperature: 3100 K  
CRI: 91

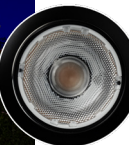

## BIG FLUX

SKU: 10103210-BL  
Output: 3.0 W  
Installation value: 4.2 VA  
Color temperature: 3100 K  
CRI: 93



## BIG SCOPE WIDE

SKU: 10401002  
Output: 5.0 W  
Installation value: 8.0 VA  
Color temperature: 3100 K  
CRI: 91

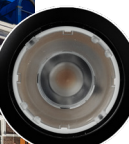

## BIG FLUX NARROW

SKU: 10103220-BL  
Output: 3.0 W  
Installation value: 2.5 VA  
Color temperature: 3100 K  
CRI: 93



## BIG SCOPE NARROW

SKU: 10400902  
Output: 5.0 W  
Installation value: 7.9 VA  
Color temperature: 3100 K  
CRI: 92



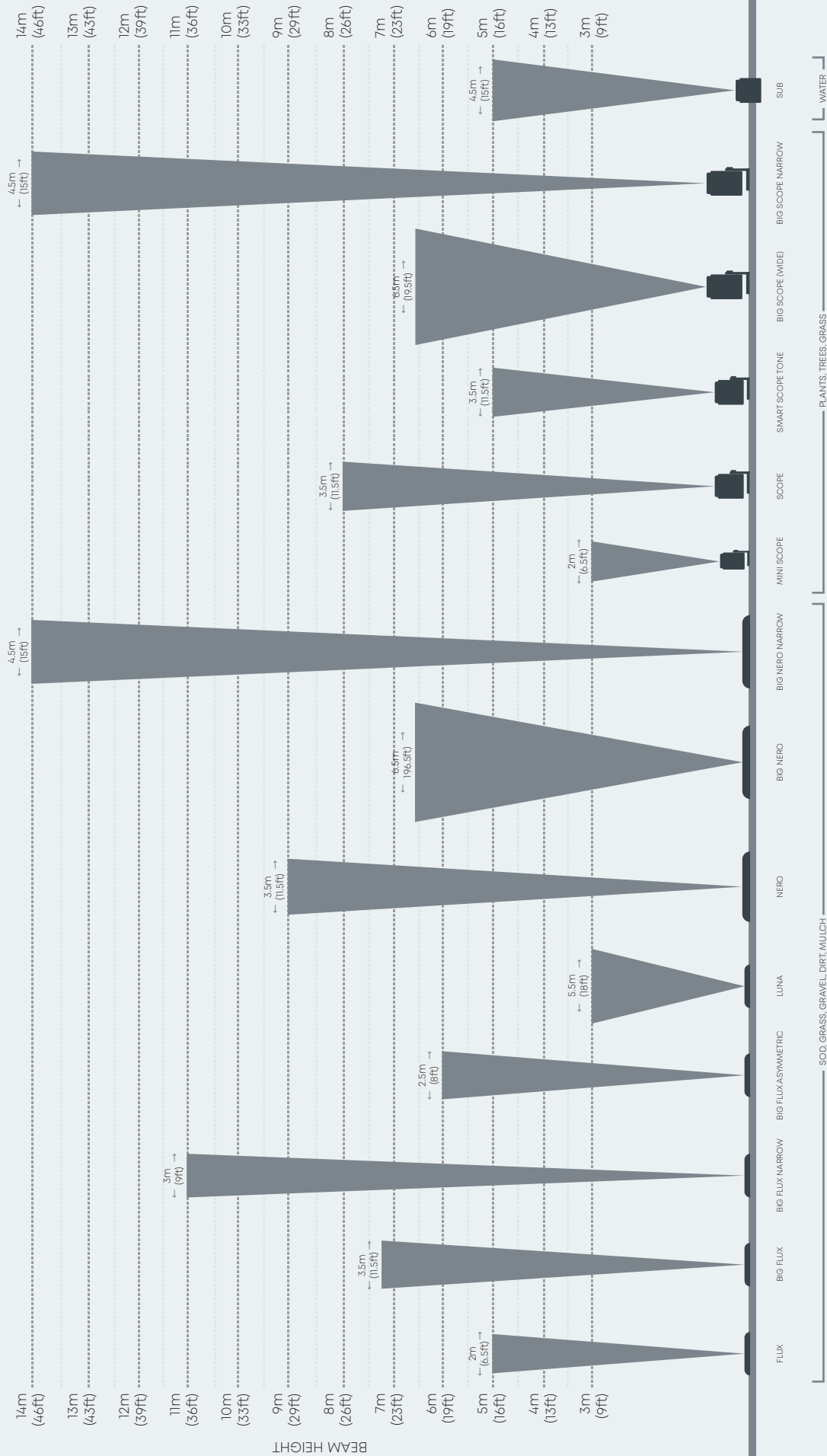

BEAM WIDTH (AT WIDEST DISTANCE)

Looking for a fixture to illuminate your outdoor space? We've put together a graphic overview of our spotlights to make it easy for you to find the right fixture for your application. Make sure to consider the size of the object you want to illuminate as well the surface in which the fixture will be installed.

SPOTS OF IN-LITE

PRODUCT ADVISOR



# WALL LIGHTS

## ACE UP-DOWN

SKU: 10301950  
 Output: 6.5 W  
 Installation value: 10.3 VA  
 Color temperature: 3000 K  
 CRI: 92

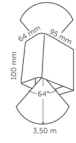

## ACE DOWN ★ MUST-HAVE

SKU: 10301850  
 Output: 3.0 W  
 Installation value: 5.3 VA  
 Color temperature: 3000 K  
 CRI: 91

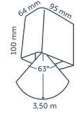

## HALO UP-DOWN ★ MUST-HAVE

SKU: 10302605  
 Output: 6.5 W  
 Installation value: 10.0 VA  
 Color temperature: 3000 K  
 CRI: 92

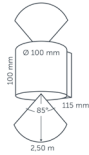

## HALO DOWN

SKU: 10302600  
 Output: 3.0 W  
 Installation value: 5.0 VA  
 Color temperature: 3000 K  
 CRI: 92

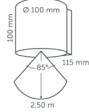

## CUBID

SKU: 10301006  
 Output: 0.5 W  
 Installation value: 0.5 VA  
 Color temperature: 2850 K  
 CRI: 93

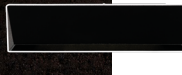
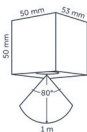

## WEDGE SLIM

SKU: 10301770  
 Output: 1.0 W  
 Installation value: 1.0 VA  
 Color temperature: 2800 K  
 CRI: 96

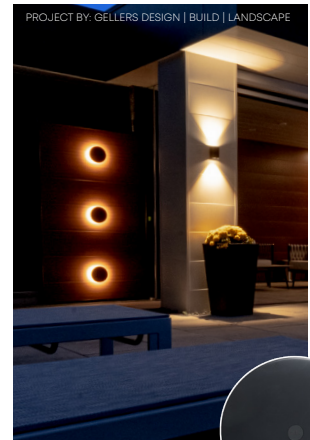

## DISC WALL

SKU: 10302700-WL  
 Output: 2.9 W  
 Installation value: 4.9 VA  
 Color temperature: 2900 K  
 CRI: 98

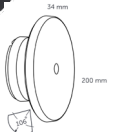



MUST-HAVE ★ **ACE**

SKU: 10202350  
 Output: 3.0 W  
 Installation value: 5.3 VA  
 Color temperature: 3000 K  
 CRI: 91

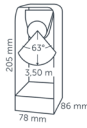

MUST-HAVE ★ **ACE HIGH**

SKU: 10201790  
 Output: 3.0 W  
 Installation value: 5.3 VA  
 Color temperature: 3000 K  
 CRI: 94



# PATH LIGHTS



**DISC**

SKU: 10202620-BL  
 Output: 4.9 W  
 Installation value: 2.5 VA  
 Color temperature: 2900 K  
 CRI: 98

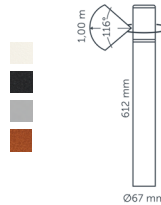
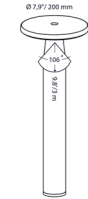

**LIV** ★ MUST-HAVE

SKU: 10201716  
 Output: 1.5 W  
 Installation value: 2.5 VA  
 Color temperature: 2750 K  
 CRI: 95

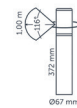

**LIV LOW** ★ MUST-HAVE

SKU: 10201761  
 Output: 1.5 W  
 Installation value: 2.5 VA  
 Color temperature: 2750 K  
 CRI: 95



**DISC LOW**

SKU: 10202640-BL  
 Output: 2.9 W  
 Installation value: 4.9 VA  
 Color temperature: 2900 K  
 CRI: 98

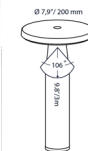

**SWAY**

SKU: 10202420-BL  
 Output: 1.0 W  
 Installation value: 1.0 VA  
 Color temperature: 2900 K  
 CRI: 95

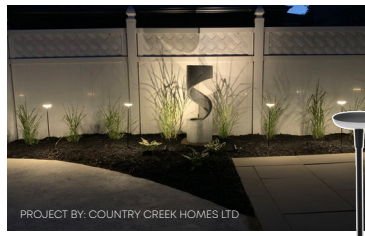

**SWAY LOW**

SKU: 10202425-BL  
 Output: 1.0 W  
 Installation value: 1.0 VA  
 Color temperature: 2900 K  
 CRI: 95

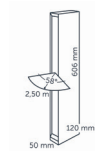

**EVO**

SKU: 10202500  
 Output: 2.0 W  
 Installation value: 2.1 VA  
 Color temperature: 2950 K  
 CRI: 95



# UNDERCAP LIGHTS

MUST-HAVE ★ **EVO HYDE 180**

SKU: 10250105  
 Output: 0.50 W  
 Installation value: 0.6 VA  
 Color temperature: 2950 K  
 CRI: 95

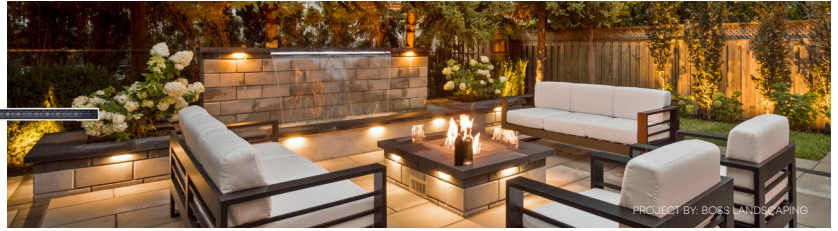

**EVO HYDE 550**

SKU: 10250150  
 Output: 2.0 W  
 Installation value: 2.1 VA  
 Color temperature: 3000 K  
 CRI: 96

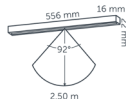

**EVO FLEX**

SKU: 10250300-1M  
 Output: 6.5 W  
 Installation value: 9.9 VA  
 Color temperature: 3000 K  
 CRI: 86



# RECESSED LIGHTS



SEE FULL  
 PRODUCT LINE

MUST-HAVE ★ **PUCK**

SKU: 10104165  
 Output: 1.5 W  
 Installation value: 2.5 VA  
 Color temperature: 2900 K  
 CRI: 96

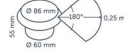

**PUCK 22**

SKU: 10104165  
 Output: 0.6 W  
 Installation value: 0.6 VA  
 Color temperature: 2900 K  
 CRI: 96



**LUNA**

SKU: 10104180-BL  
 Output: 3.0 W  
 Installation value: 5.0 VA  
 Color temperature: 3100 K  
 CRI: 94

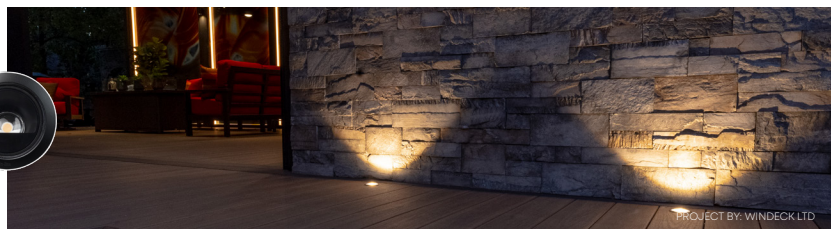
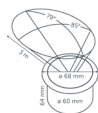



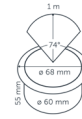
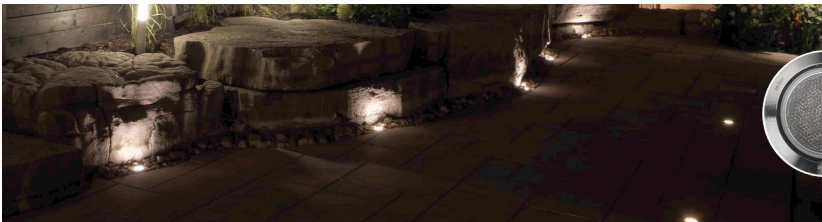

### HYVE

SKU: 10103900  
 Output: 0.8 W  
 Installation value: 0.8 VA  
 Color temperature: 3000 K  
 CRI: 95

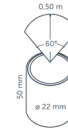

### HYVE 22

SKU: 10104050  
 Output: 0.2 W  
 Installation value: 0.2 VA  
 Color temperature: 3100 K  
 CRI: 93

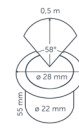
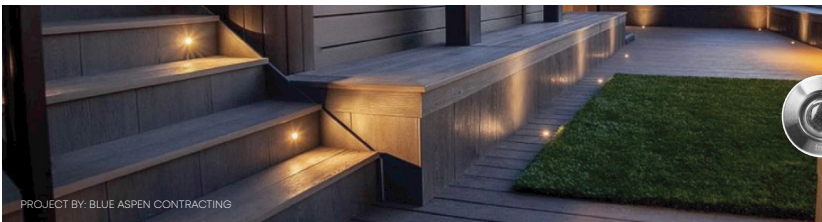

### HYVE 22 RVS ★ MUST-HAVE

SKU: 10104000  
 Output: 0.2 W  
 Installation value: 0.2 VA  
 Color temperature: 3000 K  
 CRI: 95

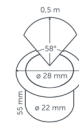
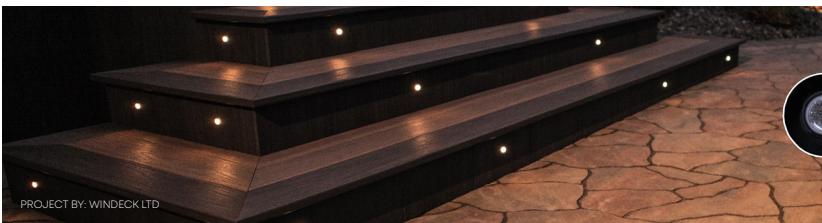

### HYVE 22 DARK

SKU: 10104090  
 Output: 0.2 W  
 Installation value: 0.2 VA  
 Color temperature: 3000 K  
 CRI: 95

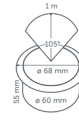
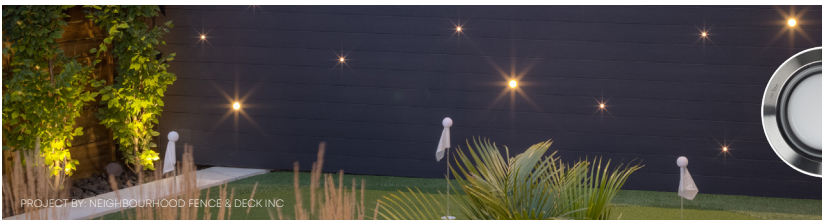

### FUSION

SKU: 10101702  
 Output: 0.9 W  
 Installation value: 1.0 VA  
 Color temperature: 2650 K  
 CRI: 93

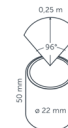

### FUSION 22

SKU: 10104100  
 Output: 0.2 W  
 Installation value: 0.2 VA  
 Color temperature: 2750 K  
 CRI: 93

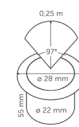

### FUSION 22 RVS ★ MUST-HAVE

SKU: 10104150  
 Output: 0.2 W  
 Installation value: 0.2 VA  
 Color temperature: 2750 K  
 CRI: 94

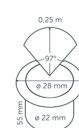
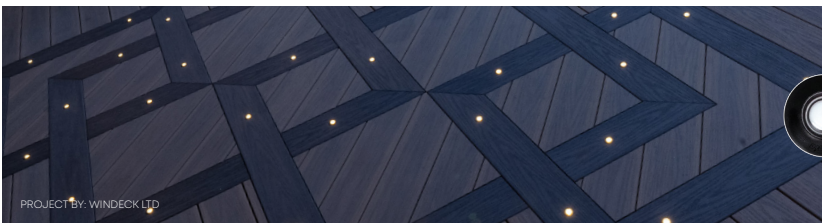

### FUSION 22 DARK

SKU: 10104190  
 Output: 0.2 W  
 Installation value: 0.2 VA  
 Color temperature: 2750 K  
 CRI: 94



# THE COMPLETE IN-LITE SYSTEM



## HUB-50 & HUB-100 ①

The HUB (or transformer) controls all the lighting in the outdoor space. The system is designed to convert the 120V line voltage from a house into 12V to power your fixtures. The HUB-50 & HUB-100 are in-lite's modern transformers featuring a touch screen, two cable ports (controlled simultaneously), and various settings such as Dusk 'til Dawn.



## CABLE ②

The low voltage cable is rolled out from the transformer and run anywhere you would like your fixtures. There are two types available: 14/2 cable and 12/2 cable. With the 14/2 cable, the cable length between the transformer and the cable end may be no longer than 40 meters (132 ft), while the 12/2 cable can handle up to 80 meters (263 ft) and is the industry standard for outdoor lighting.



## CABLE SPLIT (CC-2) ③

Want to branch off an existing main line to add more lighting? Use a CC-2 connector to split your cable in no time. Please note that a split counts in the maximum cable length between the transformer and the fixture. The maximum capacity is 50W and be sure to not 'split the split'.



## EASY-LOCK ④

The EASY-LOCK is in-lite's patented connection system with a proprietary water-proof gel to eliminate opportunities for corrosion. It comes complete with every fixture and makes installation a breeze.



## CABLE END ⑤

The cable can terminate anywhere in the yard and does not need to form a closed system. Cable caps can be placed on the cable ends for a tidy finish and to prevent moisture penetration. These are available in two sizes for different cables.

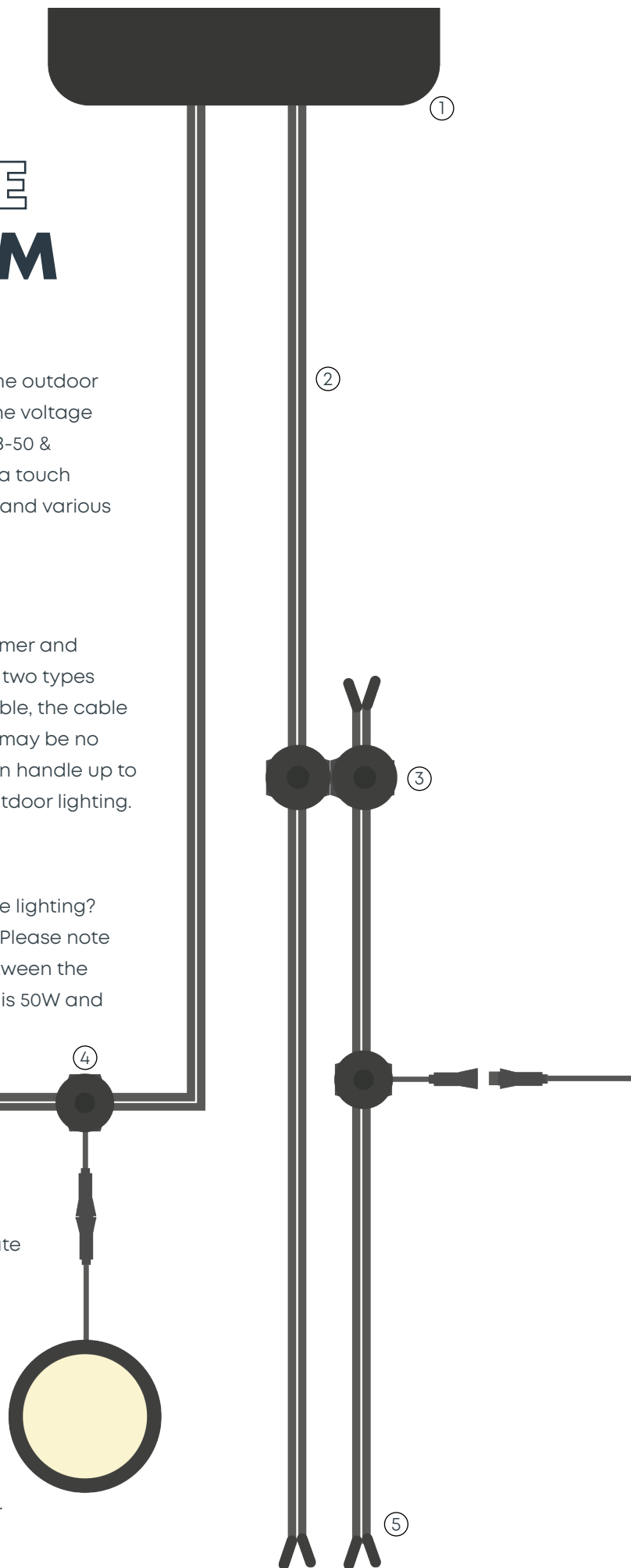



⑥



## SMART HUB-150 ⑥

The SMART HUB is the most innovative transformer in our product range and it can be operated using the in-lite app and a Bluetooth Low-Energy connection. Install the transformer and the lighting, download the in-lite app and personalize your lighting experience in no time. With the SMART HUB-150, you are able to control each cable port individually. This allows you to create different lighting zones in your outdoor space, where lights can be switched on and off at different times. Use routines to customize the timing of each zone or control them all at once using the in-lite app.

Maximum Cable Length  
14/2 cable = 40m (132 ft)  
12/2 cable = 80m (263 ft)

⑦



## ACCESSORIES ⑦

Is the cable connected to an in-lite fixture too short? Extend it with an EXTENSION cord available in 3, 6, or 9 feet. The SPLITTER can also be used to connect two fixtures to one EASY-LOCK.

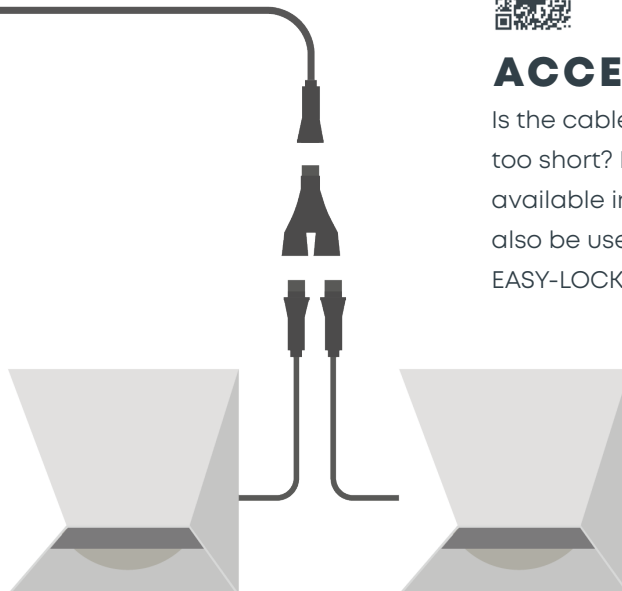



# in-sider<sup>®</sup>

by in-lite<sup>®</sup>

## BENEFITS BEYOND OUTDOOR LIGHTING

The in-sider program was created to help professionals understand, design, sell, and install landscape lighting. Our goal is to help industry pro's take their business to the next level, grow their customer base, and generate more revenue through outdoor lighting and beyond.



FIND A DEALER

We are passionate about unlocking your true potential and grow your business through outdoor lighting and beyond. By joining the in-sider program, you will have access to:

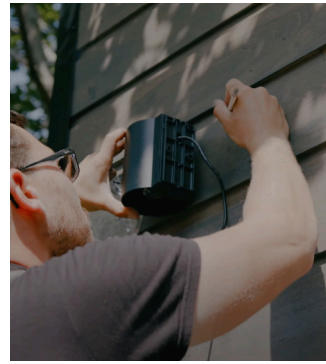

High-Quality  
Products



Training &  
Education



Continuous  
Support



Exclusive Content



Highest Quality Light  
Output in the Industry

**READY FOR FASTER INSTALLS, MORE REVENUE, BETTER PROJECTS?**

# JOIN NOW





# TECH SPECS

## LEGEND

PATH	DECK	HOUSE	GARDEN	STAIRS	PERGOLA	ACCESSORY AVAILABLE
MUST-HAVE	TREE	FENCE/WALL	PRIVACY SCREEN	TALL HEDGE	DRIVEWAY	RETAINING WALL

CORTEN	BLACK	ROSE SILVER	STAINLESS STEEL
DARK GREY	PEARL GREY	WHITE	

## WALL LIGHTS

<p><b>ACE DOWN</b> 12V / 3.0 W / 5.3 VA / 3000K / CRI 91 64 mm x 95 mm x 100 mm (LxWxH) 2.5 in x 3.7 in x 3.9 in (LxWxH)</p>	<p><b>ACE UP-DOWN</b> 12V / 6.5 W / 10.3 VA / 3000K / CRI 92 64 mm x 95 mm x 120 mm (LxWxH) 2.5 in x 3.7 in x 4.7 in (LxWxH)</p>	<p><b>HALO DOWN</b> 12V / 3.0 W / 5.0 VA / 3000K / CRI 92 H: 100 mm / 3.9 in Ø 100 mm / 3.9 in</p>	<p><b>HALO UP-DOWN</b> 12V / 6.5 W / 10 VA / 3000K / CRI 92 H: 120 mm / 4.7 in Ø 100 mm / 3.9 in</p>	<p><b>CUBID</b> 12V / 0.6 W / 0.6 VA / 2800K / CRI 93 50 mm x 53 mm x 50 mm (LxWxH) 1.9 in x 2.0 in x 1.9 in (LxWxH)</p>
<p><b>WEDGE</b> 12V / 1.0 W / 1.6 VA / 2800K / CRI 94 100 mm x 63 mm x 100 mm (LxWxH) 3.9 in x 2.4 in x 3.9 in (LxWxH)</p>	<p><b>MINI WEDGE</b> 12V / 0.6 W / 0.6 VA / 2900K / CRI 95 60 mm x 35 mm x 50 mm (LxWxH) 2.3 in x 1.3 in x 1.9 in (LxWxH)</p>	<p><b>WEDGE SLIM</b> 12V / 1.0 W / 1.0 VA / 2800K / CRI 96 200 mm x 35 mm x 50 mm (LxWxH) 7.8 in x 1.3 in x 1.9 in (LxWxH)</p>	<p><b>DISC WALL</b> 12V / 3.0 W / 4.9 VA / 2900K / CRI 98 W: 200 mm / 7.8 in</p>	<p><b>BLINK</b> 12V / 1.0 W / 1.7 VA / 2800K / CRI 95 W: 48 mm / 1.8 in Ø 100 mm / 3.9 in</p>

## PATH LIGHTS

<p><b>ACE HIGH</b> 12V / 3.0 W / 5.3 VA / 3000K / CRI 94 78 mm x 86 mm x 490 mm (LxWxH) 3.0 in x 3.3 in x 19.2 in (LxWxH)</p>	<p><b>ACE</b> 12V / 3.0 W / 5.3 VA / 3000K / CRI 91 78 mm x 86 mm x 205 mm (LxWxH) 3.0 in x 3.3 in x 8.0 in (LxWxH)</p>	<p><b>DISC</b> 12V / 3.0 W / 4.9 VA / 2900K / CRI 98 H: 600 mm / 23.6 in Ø 200 mm / 7.8 in</p>	<p><b>DISC LOW</b> 12V / 3.0 W / 4.9 VA / 2900K / CRI 98 H: 350 mm / 13.7 in Ø 200 mm / 7.8 in</p>	<p><b>SWAY</b> 12V / 1.0 W / 1.0 VA / 2900K / CRI 95 H: 1000 mm / 40 in Ø 85 mm / 3.3 in</p>
<p><b>LIV</b> 12V / 1.5 W / 2.5 VA / 2750K / CRI 95 H: 612 mm / 24.1 in Ø 67 mm / 2.6 in</p>	<p><b>LIV LOW</b> 12V / 1.5 W / 2.5 VA / 2750K / CRI 95 H: 372 mm / 14.6 in Ø 67 mm / 2.6 in</p>	<p><b>EVO</b> 12V / 2.0 W / 2.1 VA / 2950K / CRI 95 120 mm x 50 mm x 606 mm (LxWxH) 1.9 in x 4.7 in x 23.8 in (LxWxH)</p>	<p><b>EVO LOW</b> 12V / 2.0 W / 2.1 VA / 2950K / CRI 95 120 mm x 50 mm x 366 mm (LxWxH) 1.9 in x 4.7 in x 14.4 in (LxWxH)</p>	<p><b>SWAY LOW</b> 12V / 1.0 W / 1.0 VA / 2900K / CRI 95 H: 600 mm / 22.99 in Ø 85 mm / 3.3 in</p>

## TOOLS

<p><b>EXPERIENCE KIT</b> A helpful display sample bag to give your clients an in-person idea of what their space can look like.</p>	<p><b>IN-SPIRE CASE</b> A sales tool for the professional, complete with our best selling fixtures.</p>	<p><b>FULL 2D DESIGN PACKAGE</b> An end-to-end design and render to help envision an outdoor space at night.</p>	<p><b>FULL 3D DESIGN PACKAGE</b> An end-to-end design and render to help envision an outdoor space at night.</p>	<p>VIEW FULL PRODUCT LINE</p>
<p><b>60MM DIAMOND DRILL BIT (2 3/8")</b> Used to install 60mm fixtures into pavers or concrete.</p>	<p><b>22MM DIAMOND DRILL BIT (7/8")</b> Used to install 22mm fixtures into pavers or concrete.</p>	<p><b>60MM FORSTNER DRILL BIT</b> Used to install 60mm fixtures into wood or decking.</p>	<p><b>22MM FORSTNER DRILL BIT</b> Used to install 22mm fixtures into wood or decking.</p>	<p><b>WATER SWIVEL</b> An attachment piece to connect your drill to a hose for constant water stream for hardscape drilling.</p>



## RECESSED LIGHTS



**HYVE**  
12V / 0.8 W / 0.8 VA / 3000K / CRI 95  
Ø 60 mm / 2.68 in



**HYVE 22**  
12V / 0.2 W / 0.2 VA / 3100K / CRI 93  
Ø 22 mm / 0.87 in



**HYVE 22 RVS**  
12V / 0.2 W / 0.2 VA / 3000K / CRI 95  
Ø 22 mm / 1.1 in



**HYVE 22 RVS DARK**  
12V / 0.2 W / 0.2 VA / 3000K / CRI 95  
Ø 22 mm / 1.1 in



**EVO GROUND 300**  
12V / 1.0 W / 1.0 VA / 3000K / CRI 95  
300 mm x 30 mm x 43 mm (LxWxH)  
11.8 in x 1.18 in x 1.69 in (LxWxH)



**FUSION**  
12V / 0.9 W / 1.0 VA / 2650K / CRI 93  
Ø 60 mm / 2.68 in



**FUSION 22**  
12V / 0.2 W / 0.2 VA / 2750K / CRI 93  
Ø 22 mm / 0.87 in



**FUSION 22 RVS**  
12V / 0.2 W / 0.2 VA / 2750K / CRI 94  
Ø 22 mm / 1.1 in



**FUSION 22 RVS DARK**  
12V / 0.2 W / 0.2 VA / 2750K / CRI 94  
Ø 22 mm / 0.87 in



**LUNA**  
12V / 3.0 W / 5.0 VA / 3100K / CRI 94  
Ø 60 mm / 2.68 in

## SPOT LIGHTS



**MINI SCOPE DUO**  
12V / 2X 1W / 2X 2VA / 2900K / CRI 93  
Light reach: 3 m / 10 ft



**MINI SCOPE**  
12V / 1.0 W / 2.0 VA / 2900K / CRI 93  
Light reach: 3 m / 10 ft



**SCOPE**  
12V / 3.0 W / 5.2 VA / 3100K / CRI 91  
Light reach: 8 m / 20 ft



**BIG SCOPE WIDE**  
12V / 5.0 W / 8.0 VA / 3100K / CRI 91  
Light reach: 6 m / 20 ft



**BIG SCOPE NARROW**  
12V / 5.0 W / 7.9 VA / 3100K / CRI 92  
Light reach: 14 m / 46 ft



**SUB**  
12V / 3.0 W / 4.9 VA / 3100K / CRI 92  
Light reach: 5 m / 16 ft



**FLUX**  
12V / 1.5 W / 2.5 VA / 3000K / CRI 92  
Ø 60 mm / 2.68 in



**NERO**  
12V / 3.0 W / 4.7 VA / 3100 K / CRI 91  
Ø 112 mm / 5.12 in



**BIG NERO**  
12V / 7.5 W / 11.9 VA / 3100 K / CRI 91  
Ø 123 mm / 6.69 in  
Featuring in-lite Motion



**BIG NERO NARROW**  
12V / 7.5 W / 11.9 VA / 3100 K / CRI 91  
Ø 123 mm / 6.69 in  
Featuring in-lite Motion



**BIG FLUX NARROW**  
12V / 3.0 W / 4.2 VA / 3100 K / CRI 93  
Ø 60 mm / 2.68 in



**BIG FLUX**  
12V / 3.0 W / 4.2 VA / 3100K / CRI 93  
Ø 60 mm / 2.68 in

## UNDERCAP LIGHTS



**EVO HYDE 180**  
12V / 0.5 W / 0.6 VA / 2950K / CRI 95  
180 mm x 16 mm x 22 mm (LxWxH)  
7.0 in x 0.6 in x 0.8 in (LxWxH)



**EVO HYDE 550**  
12V / 2.0 W / 2.1 VA / 2950K / CRI 96  
556 mm x 16 mm x 22 mm (LxWxH)  
21.8 in x 0.6 in x 0.8 in (LxWxH)



**EVO FLEX 1M**  
12V / 6.5 W / 9.9 VA / 3000K / CRI 86  
1000 mm x 6.6 mm x 12 mm (LxWxH)  
39.37 in x 0.26 in x 0.47 in (LxWxH)









**EVO FLEX 2M**  
12V / 11.5 W / 15.7 VA / 3000K / CRI 86  
2000 mm x 6.6 mm x 12 mm (LxWxH)  
78.74 in x 0.26 in x 0.47 in (LxWxH)









**EVO FLEX 3M**  
12V / 14.5 W / 20.20 VA / 3000K / CRI 86  
3000 mm x 6.5 mm x 12 mm (LxWxH)  
118.11 in x 0.24 in x 0.47 in (LxWxH)



## SYSTEM & ACCESSORIES

 <p><b>HUB 50</b> Touchscreen transformer with a maximum installation value of 50 VA.</p>	 <p><b>HUB 100</b> Touchscreen transformer with a maximum installation value of 100 VA.</p>	 <p><b>SMART HUB-150</b> SMART transformer (in-lite app) with a maximum installation value of 150 VA.</p>	 <p><b>CBL-40 14/2</b> Low-voltage 14/2 cable. 40 m / 132 ft</p>	 <p><b>CBL-80 12/2</b> Low-voltage 12/2 cable. 80m / 262 ft</p>
 <p><b>SPLITTER</b> Cable splitter for fixtures and light sensors.</p>	 <p><b>CC-2</b> Cable branch connector.</p>	 <p><b>CBL-EXT CORD</b> Fixture lead extension cable. 1 m (3 ft) / 2 m (6 ft) / 3 m (9 ft).</p>	 <p><b>MOVE</b> Wired motion detector for HUB-50 and HUB-100.</p>	 <p><b>SMART MOVE</b> Wireless motion detector for SMART HUB-150.</p>
 <p><b>PROTECTOR</b> Protect the HUB-50, HUB-100, and SMART HUB-150 from harsh weather conditions.</p>	 <p><b>SPIKE / SPIKE 22</b> Install recessed fixtures in softscape. For specific 60 mm &amp; 22 mm fixtures.</p>	 <p><b>RISER 1 &amp; 2</b> Adjustable accessory to raise spotlights above plants. 35 cm - 53 cm (13.7 in - 20.9 in)</p>	 <p><b>SHUTTER 1 &amp; 2</b> Adjust light angle of ACE (UP) DOWN &amp; HALO (UP) DOWN.</p>	 <p><b>WINK</b> Lens cover to prevent glare on ACE bollard fixtures.</p>
 <p><b>KILLFLASH 1 &amp; 2</b> A ring with honeycomb profile to prevent glare from the light source for the SCOPE fixtures.</p>	 <p><b>SHIELD 1 &amp; 2</b> Blocks light source on one side for the SCOPE fixtures.</p>	 <p><b>SMART EXTENDER</b> Creates a stronger Bluetooth connection indoors.</p>	 <p><b>RING 68</b> Complete your LUNA ground spot light with RING 68.</p>	 <p><b>EVO FLEX-EXT CORD 1</b> An extension cord with a length of one meter for connecting the EVO FLEX (1, 2, 3).</p>
 <p><b>EVO FLEX CORNER OUTSIDE</b> A mounting bracket for creating an outside curve with a 90° angle with the EVO FLEX (1, 2, 3m).</p>	 <p><b>EVO FLEX CORNER INSIDE</b> A mounting bracket for creating an inside curve with a 90° angle with the EVO FLEX (1, 2, 3m).</p>	 <p><b>EVO FLEX CLIPS</b> For installing the EVO FLEX (1, 2, 3m) LED strip along curved or organic-shaped objects.</p>	 <p>VIEW FULL PRODUCT LINE</p>	

## NEW: COMING 2023

 <p><b>SMART EVO FLEX</b> Perfectly even line-lighting, can be installed straight or curved, and dimmed with the in-lite app.</p>	 <p><b>SMART EVO FLEX TONE</b> Perfectly even RGB line-lighting and warm white, can be installed straight or curved, and dimmed with the in-lite app.</p>	 <p><b>SMART SCOPE TONE</b> Both RGB and familiar warm white. Suitable for all tree types, both tall and short, and dimmed with the in-lite app.</p>	 <p><b>EVO FLEX PROFILE SINGLE</b> A straight profile with a length of 40 inches for mounting EVO FLEX.</p>
 <p><b>BRIDGE</b> Creates a bridge to the internet in order to integrate with 'smart home' systems.</p>	 <p><b>SWAY CAP</b> Place on top of MINI SWAY and SWAY for different looks in your outdoor space.</p>	 <p><b>EVO FLEX SPIKE</b> Install the EVO FLEX in softscape applications with the EVO FLEX SPIKE.</p>	



# 25

YEARS OF IN-LITE

## LET'S CONNECT

The in-lite team is dedicated to providing you with the educational and inspirational content you need to succeed with landscape lighting and beyond.



[info@in-lite.com](mailto:info@in-lite.com)

[www.in-lite.com](http://www.in-lite.com)